

FOR YOUR SAFETY WARNING: BE SURE THE ELECTRICITY TO THE WIRES YOU ARE WORKING ON IS SHUT OFF; EITHER THE FUSE IS REMOVED OR THE CIRCUIT BREAKER IS SHUT OFF.

GENERAL You don't need special tools to install this fixture. Be sure to follow the steps in the order given. Under no circumstances should a fixture be hung on house electrical wires, nor should a swag type fixture be installed on a ceiling which contains a radiant type heating system. Read instructions carefully. If you are unclear as to how to proceed, consult a qualified electrician.

NOTE: Proper wiring is essential for the safe operation of this fixture.

ASSEMBLY INSTRUCTIONS

553PHB-LED

560PHB-LED

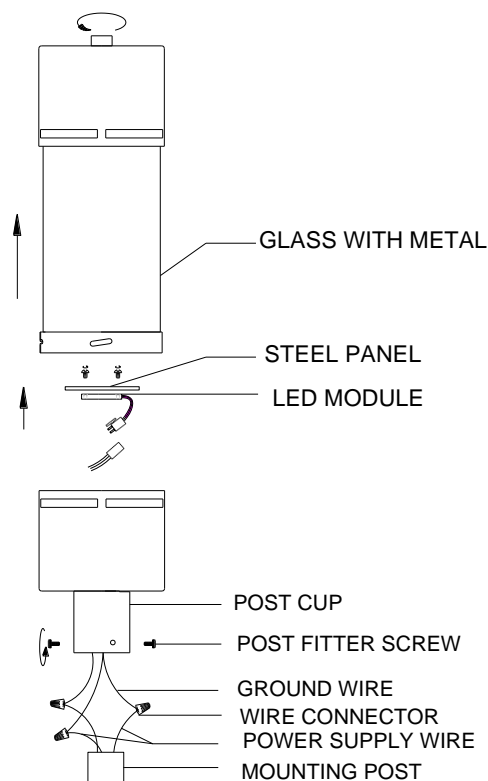

READ & SAVE

INSTALLATION & OPERATION INSTRUCTIONS

TOOLS & MATERIALS REQUIRED

Screwdriver

Wire Cutters

Adjustable Wrench

Wiring Supplies

CAUTION

Prior to assembly, refer to ELECTRICAL CONNECTIONS section. If you do not have electrical wiring experience, refer to a do-it-yourself wiring handbook or have your fixture installed by a qualified licensed electrician.

GENERAL

1. Be sure to read these instructions and review the diagrams thoroughly before beginning.
2. Electrical connections must be in accordance with local codes, ordinances, or the National Electric Code. If you are unfamiliar with methods of installing electrical wiring, secure the services of a qualified licensed electrician.
3. Before starting the installation, disconnect the power by turning off the circuit breaker or by removing appropriate fuse at fuse box. Turning the power off at the light switch is not sufficient to prevent electrical shock.

PREPARE THE FIXTURE

NOTE: First turn off electricity

FINAL ASSEMBLY

1. Pull the black, white and ground wires out of mounting post.
2. While supporting the fixture, connect electrical wires. If your post has a ground wire (green or bare copper), connect the fixture ground wire to it. If not, consult your electrician for proper grounding.

ELECTRICAL CONNECTIONS 120V~, 60Hz

Connect white wire(s) from fixture to white neutral wire from supply circuit.

Connect black wire(s) to black hot wire from supply circuit. Connect green wire to green or bare wire or grounding screw on mounting bracket. In all cases grounding conductor to earth must be used. Use UL/CSA Listed wire connects suitable for the size, type, and number of conductors. No loose strands or loose wires should be present. Secure wire connectors with UL/CSA Listed electrical tape.

After wires are connected, tuck them carefully inside the post cup.

3. Align the lantern with mounting post and secure with screws
4. Installation is complete. Turn on the power at the circuit breaker or fuse box. Turn the light switch on to activate the fixture.
5. LED replacement, take down the glass with metal parts, unscrew the screws on LED and pull out LED module, replace LED module by quick connector. Then feed the new LED module back and secure with screws.

CAUTION: LED fixtures can operate at high temperatures please use caution when touching during operation or after operation.

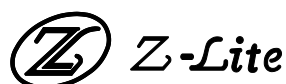

Please observe local building/electrical codes regarding the installation of your post fixture. Please keep in mind your geographic location and the depth that the ground freezes to, when deciding the depth of your installation.

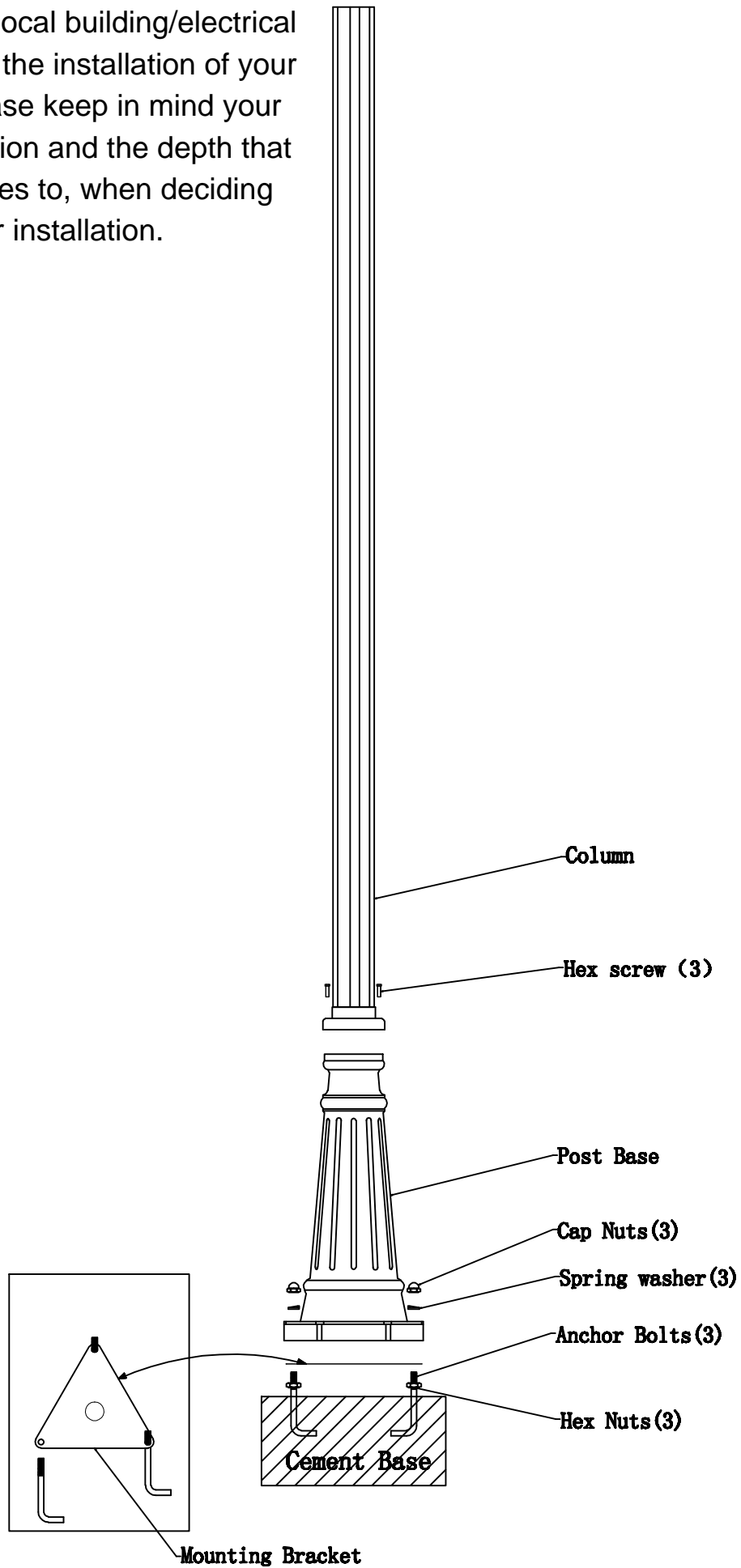

519P-BK